

[增强六类屏蔽扩展模块 LKE119-C6AS]

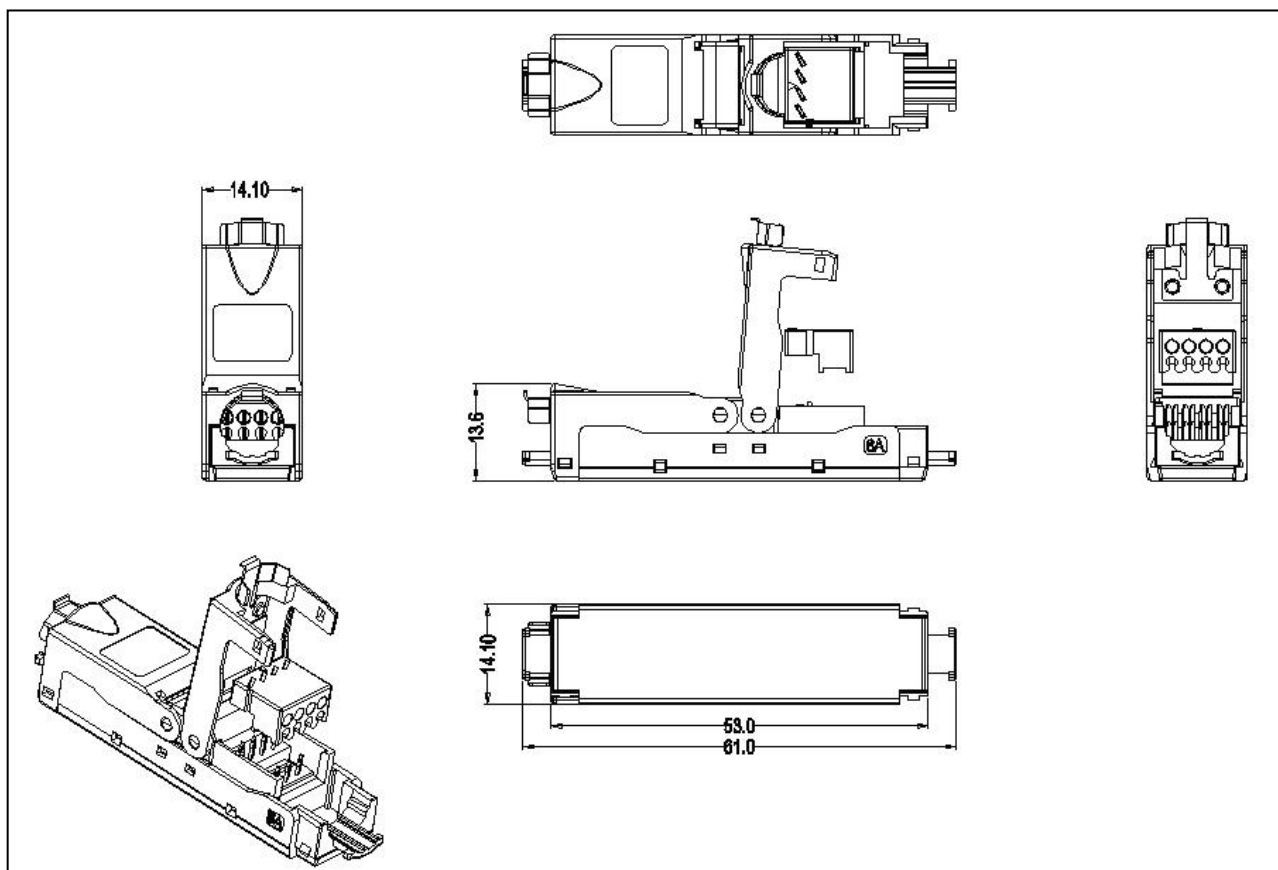

[产品结构图]



宁波多普勒通讯有限公司
Ningbo Doppler Communication Co., Ltd.

地址：浙江省余姚市经济开发区凤仪路86号
Address: No.86 fengyi road, economic development zone,
yuyao city, zhejiang province
E-mail : sale@dopplercabling.com
www.dopplercabling.com

业务热线：

联系人：杜先生 手机：13805807079

邮箱：duj@dopplercabling.com



[产品描述]

- 增强六类屏蔽扩展模块超越了所有增强六类部件的性能要求，符合万兆以太网应用系统，可提供高达 500MHz 的可用带宽，可以在没有过多的费用的情况下延长线路。此外，关闭的线路可以被重新激活，并且可以被延长到下一个所需的连接。因此，电缆管道中的狭窄空间被最佳地利用。安装者可简单地将扩展模块拧入安装在管道或墙壁上的管道的末端。在安装完成后，以这种方式延伸的线路可以被用于最大链路长度。

[技术特性]

- 自主的外观设计，简洁美观更紧凑
- 独特的 PCB 线路板线对平衡设计，减少干扰，通过余量高
- 端接外壳材料采用锌合金材料
- 具有可向下兼容 CAT6 及更低类别的系统

[传输性能]

描述	描述
接触电阻（最大）	20mΩ
绝缘电阻（最小）	500MΩ
回波损耗（dB）	5.0dB

宁波多普勒通讯有限公司
Ningbo Doppler Communication Co., Ltd.

地址：浙江省余姚市经济开发区凤仪路86号
Address: No.86 fengyi road, economic development zone,
yuyao city, zhejiang province
E-mail : sale@dopplercabling.com
www.dopplercabling.com

业务热线：

联系人：杜先生 手机：13805807079
邮箱：duj@dopplercabling.com



Cable ID: LKE119-C6AS
 Date / Time: 09/28/2018 01:23:20 PM
 Headroom 3.6 dB (NEXT 36-78)
 Test Limit: ISO11801 PL3 Class Ea
 Cable Type: Cat 6A F/UTP
 NVP: 74.0%

Software Version: V5.5 Build 2
 Limits Version: V6.3
 Calibration Start Date:
 Main (Module): 06/27/2018
 Remote (Module): 06/27/2018

Test Summary: PASS
 Model: DSX-8000
 Main S/N: 1820424
 Remote S/N: 1820428
 Main Adapter: DSX-PLA804
 Remote Adapter: DSX-PLA804

Length (ft), Limit 295	[Pair 45]	162
Prop. Delay (ns), Limit 498	[Pair 36]	225
Delay Skew (ns), Limit 44	[Pair 12]	2
Resistance (ohms), Limit 21.00	[Pair 78]	7.78
Insertion Loss Margin (dB)	[Pair 36]	17.5
Frequency (MHz)	[Pair 36]	500.0
Limit (dB)	[Pair 36]	42.1

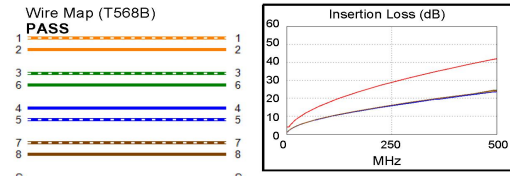
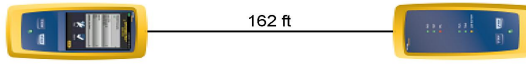

	Worst Case Margin		Worst Case Value	
PASS	MAIN	SR	MAIN	SR
Worst Pair	36-78	36-78	36-45	36-45
NEXT (dB)	3.6	4.0	10.2	10.9
Freq. (MHz)	20.6	19.8	496.0	496.0
Limit (dB)	52.9	53.2	28.0	28.0
Worst Pair	78	78	36	36
PS NEXT (dB)	3.5	3.7	10.4	9.9
Freq. (MHz)	20.6	19.8	497.0	498.0
Limit (dB)	50.5	50.8	24.9	24.9

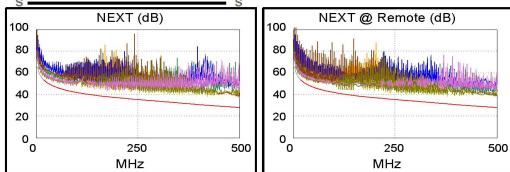

	MAIN		SR	
PASS	MAIN	SR	MAIN	SR
Worst Pair	12-45	45-12	45-12	12-45
ACR-F (dB)	14.5	14.5	18.2	18.7
Freq. (MHz)	5.6	5.6	366.0	366.0
Limit (dB)	49.2	49.2	12.9	12.9
Worst Pair	45	45	12	36
PS ACR-F (dB)	15.0	15.1	19.8	22.4
Freq. (MHz)	5.6	5.8	362.0	500.0
Limit (dB)	46.2	46.0	10.0	7.2

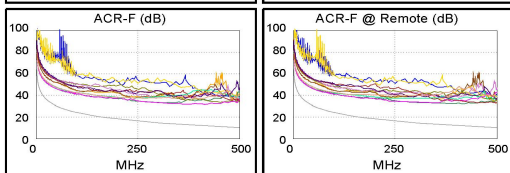

	MAIN		SR	
PASS	MAIN	SR	MAIN	SR
Worst Pair	36-78	36-78	36-45	36-78
ACR-N (dB)	7.1	7.6	28.9	28.6
Freq. (MHz)	20.4	19.8	500.0	498.0
Limit (dB)	45.1	45.4	-14.2	-14.0
Worst Pair	78	78	36	36
PS ACR-N (dB)	7.0	7.2	27.8	27.4
Freq. (MHz)	20.4	19.6	497.0	498.0
Limit (dB)	42.7	43.1	-17.0	-17.1

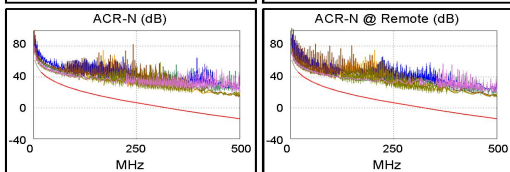

	MAIN		SR	
PASS	MAIN	SR	MAIN	SR
Worst Pair	78	45	78	45
RL (dB)	5.7	5.0	5.7	5.0
Freq. (MHz)	480.0	355.0	480.0	355.0
Limit (dB)	8.0	8.5	8.0	8.5

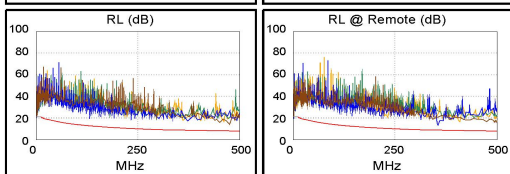

Compliant Network Standards:
 10BASE-T 100BASE-TX 100BASE-T4
 1000BASE-T 10GBASE-T ATM-25
 ATM-S1 ATM-155 100VG-AnyLan
 TR-4 TR-16 Active TR-16 Passive

LinkWare™ PC Version 9.9

Project: DEFAULT

1.fiw



[订购信息]

型号	名称	标准颜色	小包装	大包装	外箱尺寸 (L×W×H)	重量
LKE119-C6AS	超六类屏蔽扩展模块	银色	25PCS	250PCS	53cm × 31cm × 23cm	7.5KG

宁波多普勒通讯有限公司
 Ningbo Doppler Communication Co., Ltd.

地址: 浙江省余姚市经济开发区凤仪路86号
 Address: No.86 fengyi road, economic development zone,
 yuyao city, zhejiang province
 E-mail: sale@dopplercabling.com
 www.dopplercabling.com

业务热线:

联系人: 杜先生 手机: 13805807079
 邮箱: duj@dopplercabling.com

